

TS10N60

10A 600V N-Channel Power Mosfet

DRAWING

Features

- ◆ 10A,600V, $R_{DS(ON)}=0.80\Omega@V_{GS}=10V$
- ◆ Ultra low gate charge(typical 44nc)
- ◆ Low Reverse transfer capacitance (C_{rs} typical 18PF)
- ◆ Fast switching capability
- ◆ 100%avalanche energy specified
- ◆ Improved dv/dt capability, high ruggedness

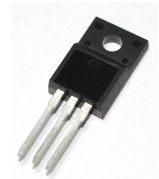

G D S

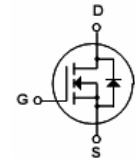

General Description

- ◆ Package:ITO-220AB(DG)
- ◆ This advanced technology has been especially tailored to minimize on-state resistance, provide superior switching performance, and withstand high energy pulse in the avalanche and commutation mode. These devices are well suited for high efficiency switch mode power supply.

Absolute Maximum Ratings

Symbol	Parameter	Spec	Units
V_{DSS}	Drain-Source Voltage	600	V
I_D	Drain Current -Continuous($T_c=25^\circ C$)	10	A
I_{AR}	Avalanche Current	10	A
I_{DM}	Drain Current -Pulsed	38	A
V_{GSS}	Gate-Source Voltage	± 30	V
E_{AS}	Single Pulsed Avalanche Energy	700	mJ
E_{AR}	Repetitive Avalanche Energy	15.6	mJ
dv/dt	Peak Diode Recovery dv/dt	4.5	V/ns
P_D	Power Dissipation	46	W
T_j	Junction Temperature	+150	$^\circ C$
T_{opr}	Operating Temperature Range	-55 to +150	$^\circ C$
T_{stg}	Storage Temperature	-55 to +150	$^\circ C$

Thermal Characteristics

Symbol	Parameter	Typ	Max	Units
$R_{\theta JC}$	Thermal Resistance, Junction-to-Case	-	3.8	$^\circ C/W$
$R_{\theta JA}$	Thermal Resistance, Junction-to-Ambient	-	62.5	$^\circ C/W$

Electrical Characteristics(Tc=25°C unless otherwise noted)
Off Characteristics

Symbol	Parameter	Test Conditions	Min	Typ	Max	Units
BV _{DSS}	Drain-Source Breakdown Voltage	V _{GS} =0V, I _D =250uA	600	—	—	V
BV _{DSS/TJ}	Breakdown Voltage Temperature Coefficient	ID=250uA, Referenced to 25°C	—	0.7	—	V/°C
I _{DSS}	Zero Gate Voltage Drain Current	V _{DS} =600V, V _{GS} =0V	—	—	1	uA
		V _{DS} =480V, T _C =125°C	—	—	100	uA
I _{GSSF}	Gate-Body Leakage Current, Forward	V _{GS} =30V, V _{DS} =0V	—	—	100	nA
I _{GSSR}	Gate-Body Leakage Current, Reverse	V _{GS} =-30V, V _{DS} =0V	—	—	-100	nA

On Characteristics

Symbol	Parameter	Test Conditions	Min	Typ	Max	Units
V _{GS(TH)}	Gate Threshold Voltage	V _{DS} =V _{GS} , I _D =250uA	2.0	—	4.0	V
R _{DS(on)}	Static Drain-Source On-Resistance	V _{GS} =10V, I _D =6A	—	0.65	0.80	Ω

Dynamic Characteristics

Symbol	Parameter	Test Conditions	Min	Typ	Max	Units
C _{JSS}	Input Capacitance	V _{DS} =25V, V _{GS} =0V, f=1.0MHz	—	2100	2840	pF
C _{OSS}	Output Capacitance		—	166	215	pF
C _{rss}	Reverse Transfer Capacitance		—	14	20	pF

Switching Characteristics

Symbol	Parameter	Test Conditions	Min	Typ	Max	Units
t _{don}	Turn-On Delay Time	V _{DD} =300V I _D =12A R _G =25Ω	—	23	55	ns
t _r	Turn-On Rise Time		—	69	150	ns
t _{doff}	Turn-Off Delay Time		—	144	300	ns
t _f	Turn-Off Fall Time	V _{DS} =480V I _D =12A V _{GS} =10V	—	77	165	ns
Q _g	Total Gate Charge		—	44	57	nc
Q _{gs}	Gate-Source Charge		—	6.7	—	nc
Q _{gd}	Gate-Drain Charge	—	18.5	—	nc	

Drain-Source Diode Characteristics and Maximum Ratings

Symbol	Parameter	Test Conditions	Min	Typ	Max	Units
I _S	Maximum Continuous Drain-source diode forward current		—	—	10	A
I _{sm}	Maximum pulsed drain-source diode forward current		—	—	38	A
V _{sd}	Drain-source diode forward Voltage	V _{GS} =0V, I _S =6.2A	—	—	1.5	V
T _{rr}	Reverse Recovery Time	V _{GS} =0V, I _S =6.2A	—	420	—	ns
Q _{rr}	Reverse Recovery charge	dif/dt=100A/us	—	4.2	—	uc

Typical Characteristics

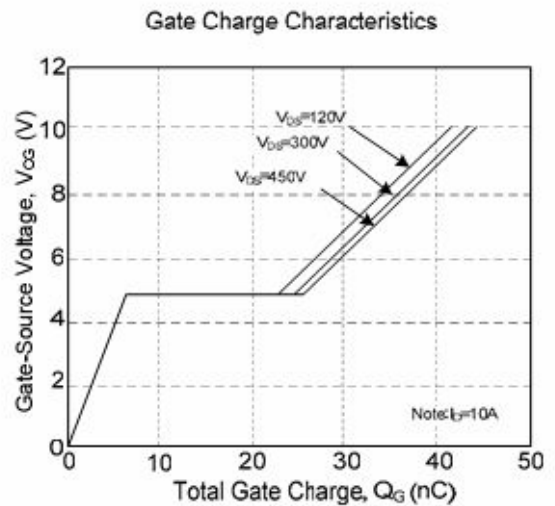
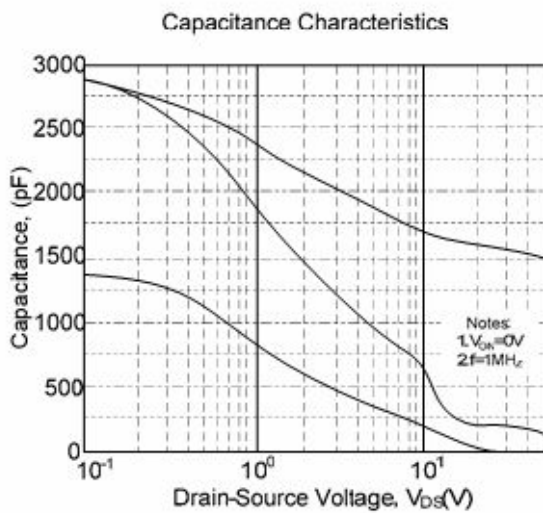
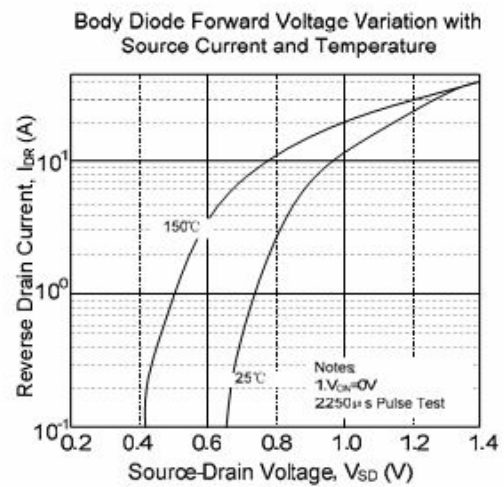
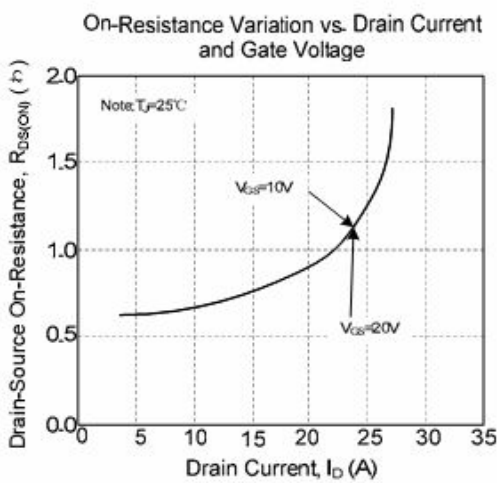
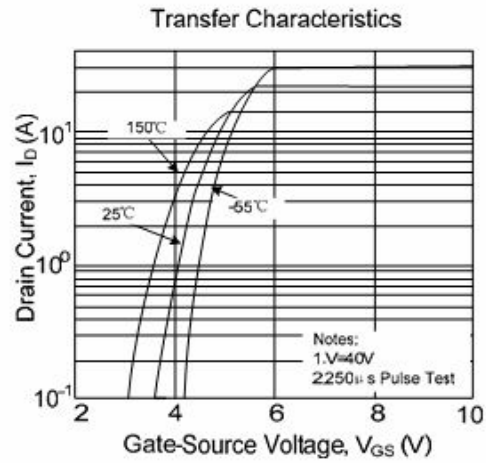
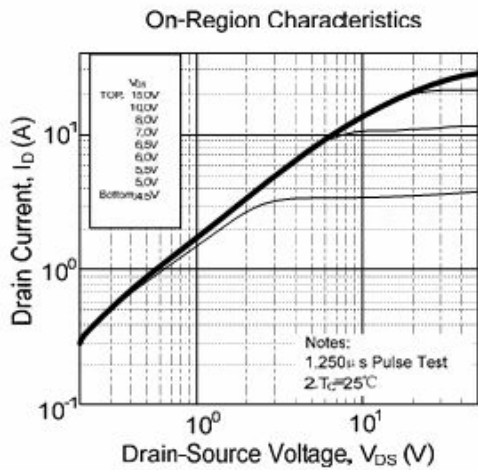

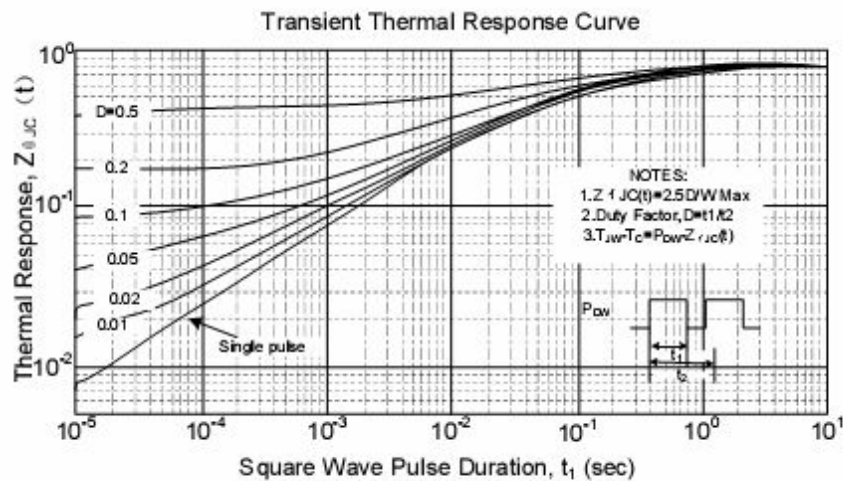
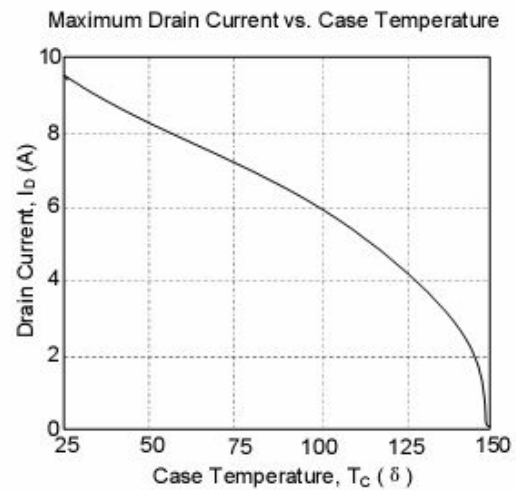
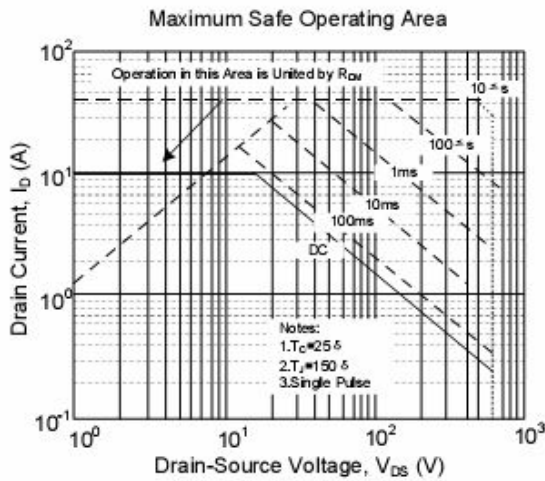
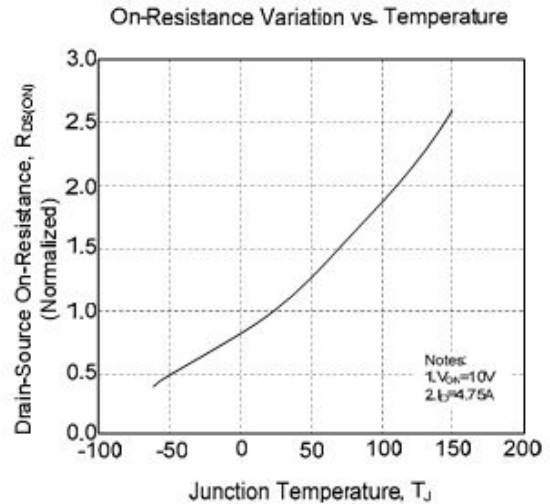
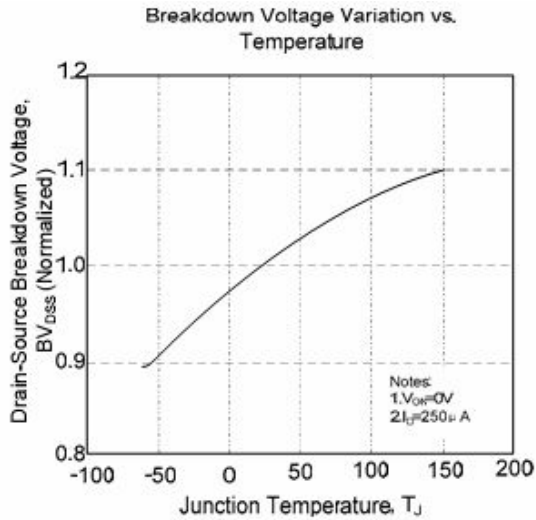

Test circuits and waveforms

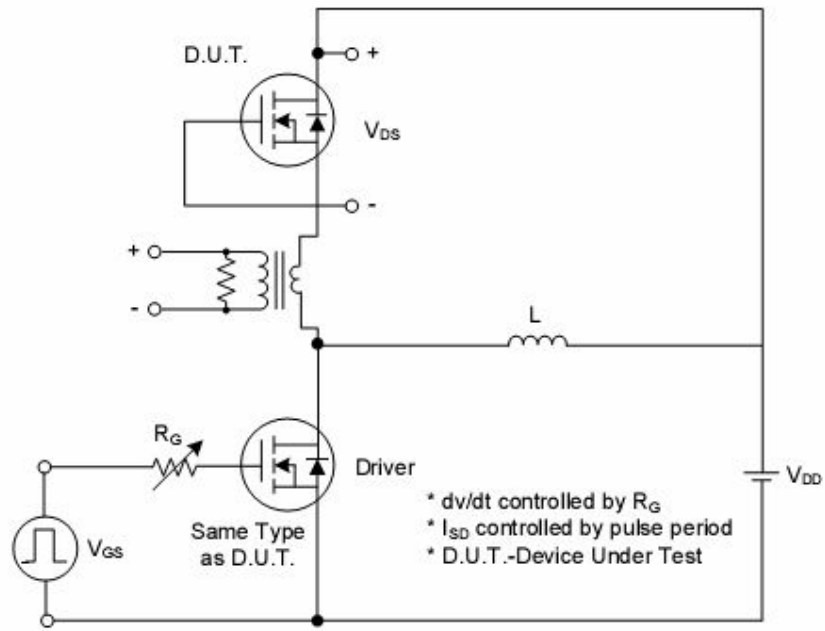

Fig. 1A Peak Diode Recovery dv/dt Test Circuit

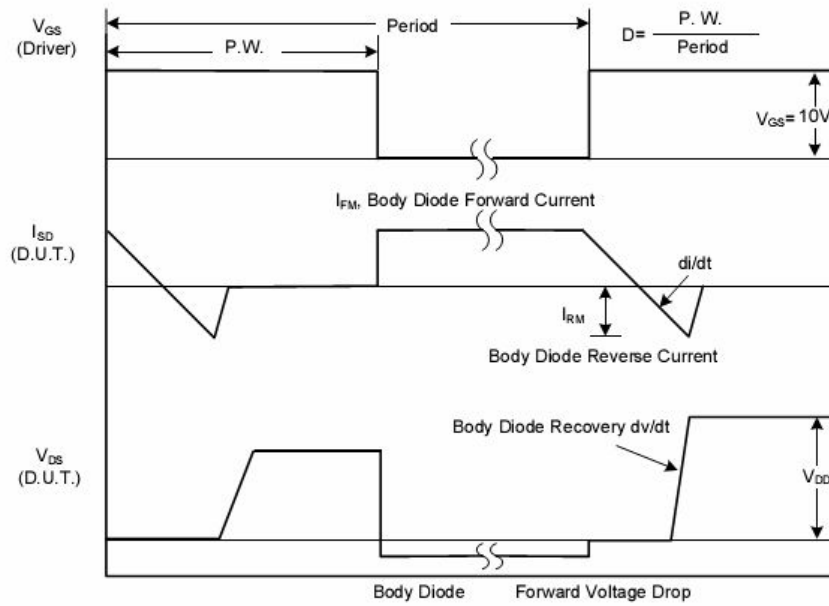

Fig. 1B Peak Diode Recovery dv/dt Waveforms

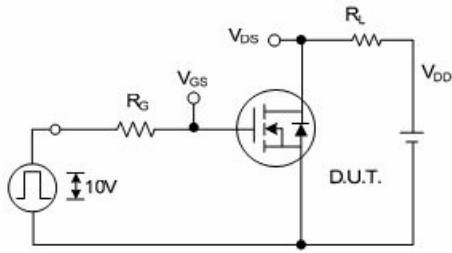

Fig. 2A Switching Test Circuit

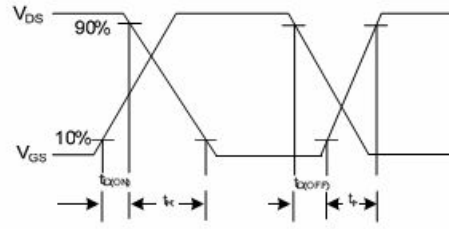

Fig. 2B Switching Waveforms

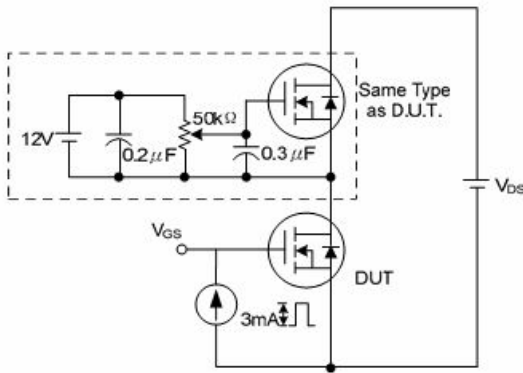

Fig. 3A Gate Charge Test Circuit

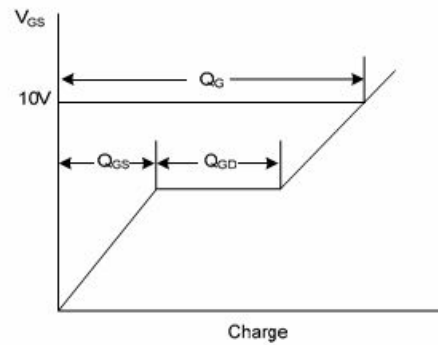

Fig. 3B Gate Charge Waveform

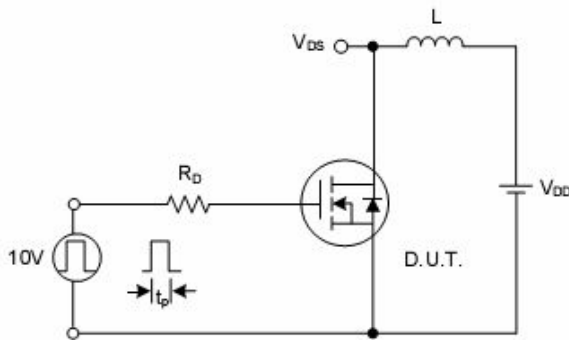

Fig. 4A Unclamped Inductive Switching Test Circuit

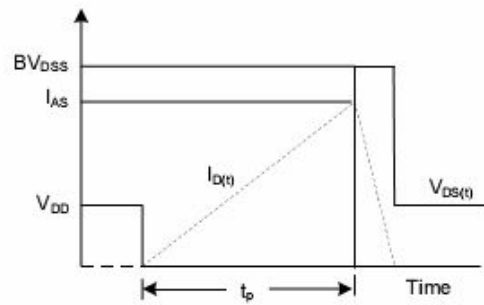

Fig. 4B Unclamped Inductive Switching Waveforms

Mechanical Dimensions

