

8N60A

7.5Amps, 600V N-Channel Power Mosfet

DRAWING

Features

- ◆ 7.5A,600V, $R_{DS(ON)}=1.0\Omega@V_{GS}=10V$
- ◆ Ultra low gate charge(typical 28nc)
- ◆ Low reverse transfer capacitance (C_{RSS} =typical 12.0 PF)
- ◆ Fast switching capability
- ◆ Avalanche energy specified
- ◆ Improved dv/dt capability, high ruggedness

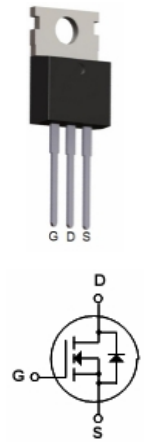

General Description

- ◆ Package:TO-220C
- ◆ This is a high voltage and high current power MOSFET ,Designed to have better characteristics, such as fast switching time , low gate charge, low on-state resistance and have a high rugged avalanche characteristics.This power MOSFET is usually used at high speed switching applications in power supplies ,PWM motor controls. High Efficient DC to DC converters and bridge circuits.

Absolute Maximum Ratings

Symbol	Parameter	Spec	Units
V_{DSS}	Drain-Source Voltage	600	V
I_D	Drain Current -Continuous($T_c=25^\circ C$)	7.5	A
I_{DM}	Drain Current -Pulsed	30	A
I_{AR}	Avalanche Current	7.5	A
V_{GSS}	Gate-Source Voltage	± 30	V
E_{AS}	Single Pulsed Avalanche Energy	230	mJ
E_{AR}	Repetitive Avalanche Energy	14.7	mJ
dv/dt	Peak Diode Recovery dv/dt	4.5	V/ns
P_D	Power Dissipation	147	W
T_j	Junction Temperature	+150	$^\circ C$
T_{opr}	Operating Temperature Range	-55 to +150	$^\circ C$
T_{stg}	Storage Temperature	-55 to +150	$^\circ C$

Thermal Characteristics

Symbol	Parameter	Typ	Max	Units
$R_{\theta JC}$	Thermal Resistance, Junction-to-Case	—	0.85	$^\circ C/W$
$R_{\theta JA}$	Thermal Resistance, Junction-to-Ambient	—	62.5	$^\circ C/W$

Electrical Characteristics(Tc=25°C unless otherwise noted)
Off Characteristics

Symbol	Parameter	Test Conditions	Min	Typ	Max	Units
BV _{DSS}	Drain-Source Breakdown Voltage	V _{GS} =0V, I _D =250uA	600	—	—	V
BV _{DSS} /T _J	Breakdown Voltage Temperature Coefficient	ID=250uA, Referenced to 25°C	—	0.7	—	V/°C
I _{DSS}	Zero Gate Voltage Drain Current	V _{DS} =600V, V _{GS} =0V	—	—	1	uA
I _{GSSF}	Gate-Body Leakage Current, Forward	V _{GS} =30V, V _{DS} =0V	—	—	100	nA
I _{GSSR}	Gate-Body Leakage Current, Reverse	V _{GS} =-30V, V _{DS} =0V	—	—	-100	nA

On Characteristics

Symbol	Parameter	Test Conditions	Min	Typ	Max	Units
V _{GSTH}	Gate Threshold Voltage	V _{DS} =V _{GS} , I _D =250uA	2.0	—	4.0	V
R _{DS(on)}	Static Drain-Source On-Resistance	V _{GS} =10V, I _D =4A	—	0.86	1.0	Ω

Dynamic Characteristics

Symbol	Parameter	Test Conditions	Min	Typ	Max	Units
C _{JSS}	Input Capacitance	V _{DS} =25V, V _{GS} =0V, f=1.0MHz	—	1530	2100	pF
C _{OSS}	Output Capacitance		—	110	155	pF
C _{RSS}	Reverse Transfer Capacitance		—	12	16	pF

Switching Characteristics

Symbol	Parameter	Test Conditions	Min	Typ	Max	Units
t _{don}	Turn-On Delay Time	V _{DD} =300V I _D =7.5A R _G =25Ω	—	16.5	45	ns
t _r	Turn-On Rise Time		—	60.5	130	ns
t _{doff}	Turn-Off Delay Time		—	81	170	ns
t _f	Turn-Off Fall Time		—	64.5	140	ns
Q _g	Total Gate Charge	V _{DS} =480V	—	28	36	nc
Q _{gs}	Gate-Source Charge	I _D =7.5A	—	4.5	—	nc
Q _{gd}	Gate-Drain Charge	V _{GS} =10V	—	12	—	nc

Drain-Source Diode Characteristics and Maximum Ratings

Symbol	Parameter	Test Conditions	Min	Typ	Max	Units
I _S	Maximum Continuous Drain-source diode forward current		—	—	7.5	A
I _{SM}	Maximum pulsed drain-source diode forward current		—	—	30	A
V _{SD}	Drain-source diode forward Voltage	V _{GS} =0V, I _S =7A	—	—	1.4	V
T _{rr}	Reverse Recovery Time	V _{GS} =0V, I _S =7A	—	365	—	ns
Q _{rr}	Reverse Recovery charge	dif/dt=100A/us	—	3.4	—	uc

Typical Characteristics

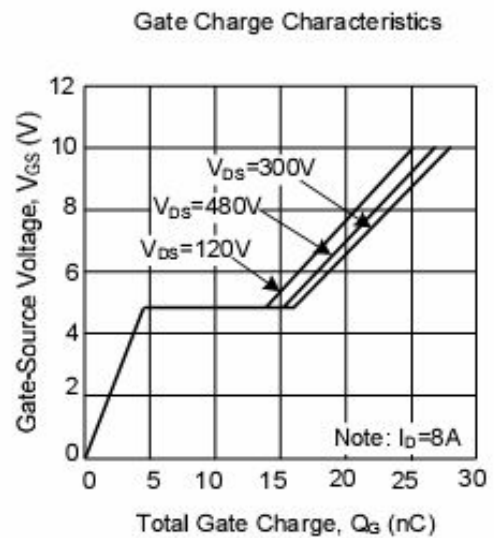
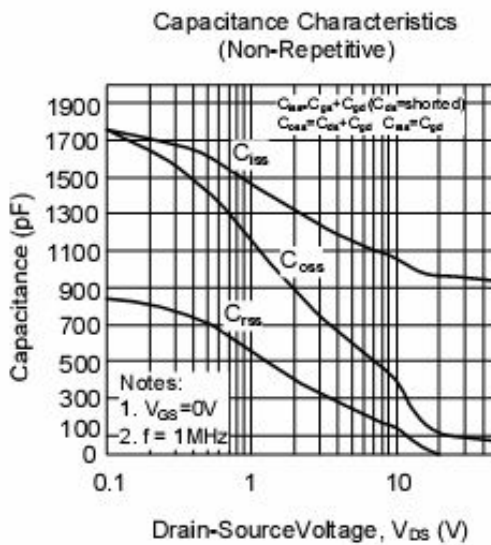
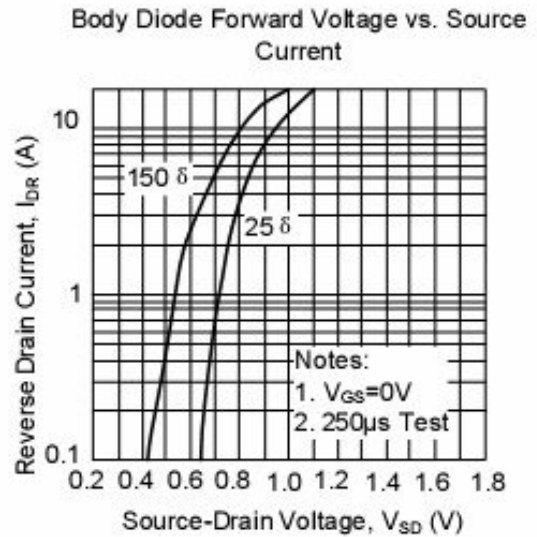
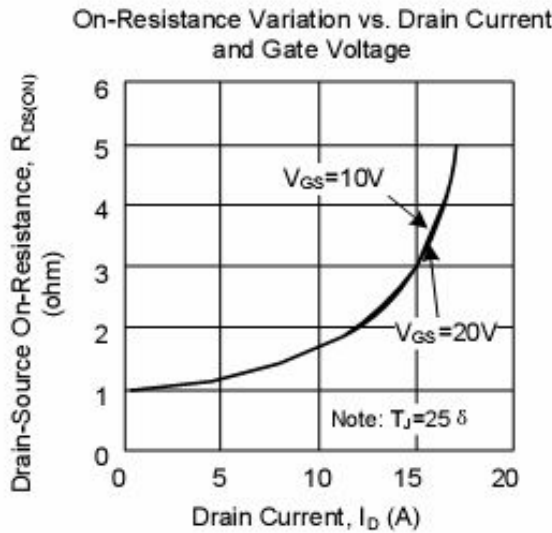
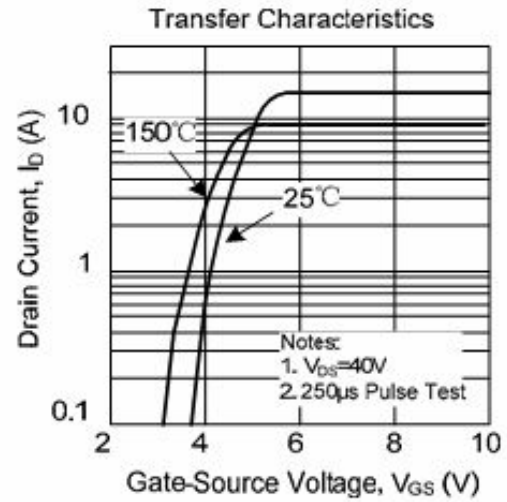
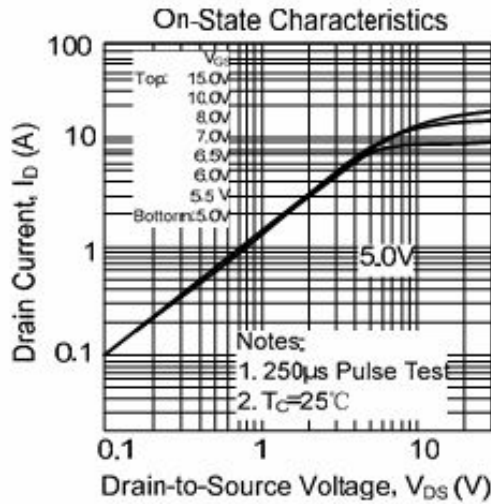

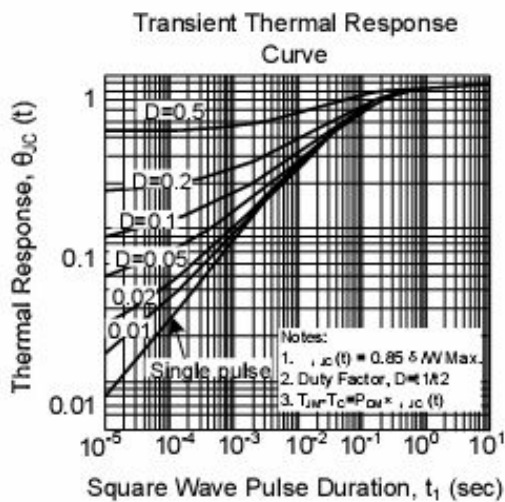
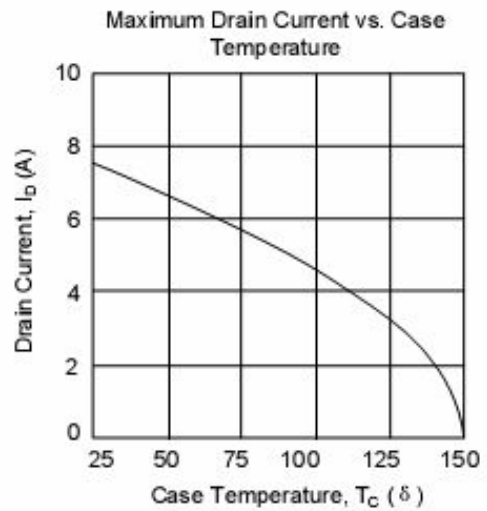
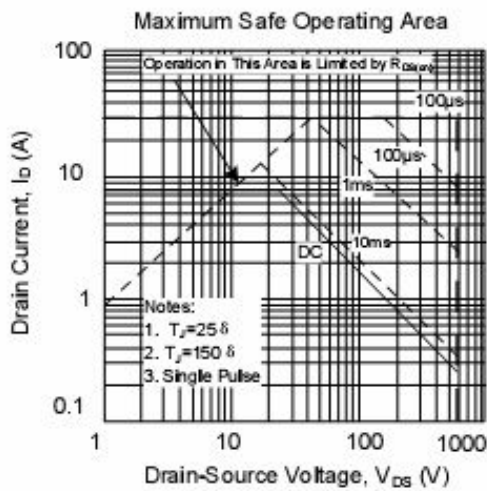
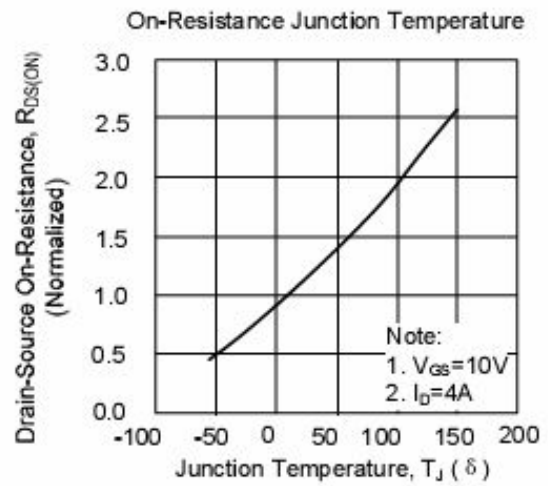
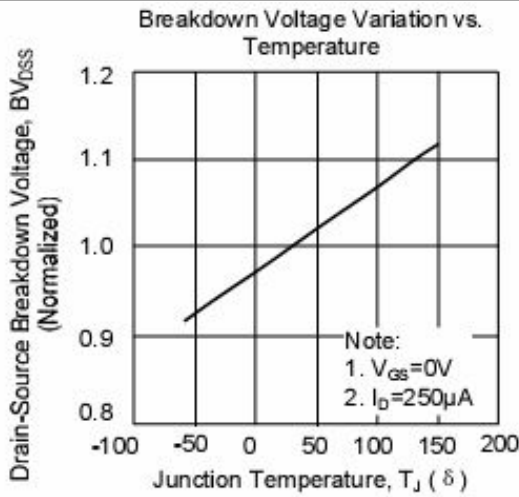

Test circuits and waveforms

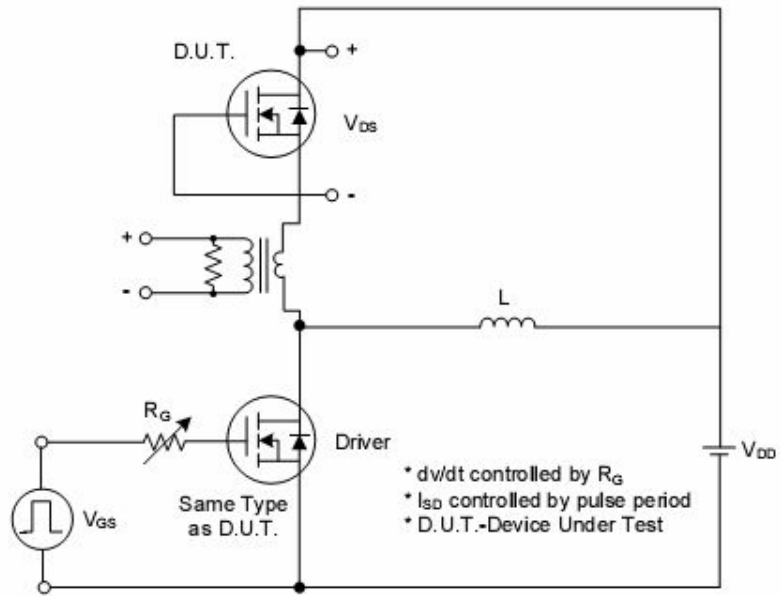

Fig. 1A Peak Diode Recovery dv/dt Test Circuit

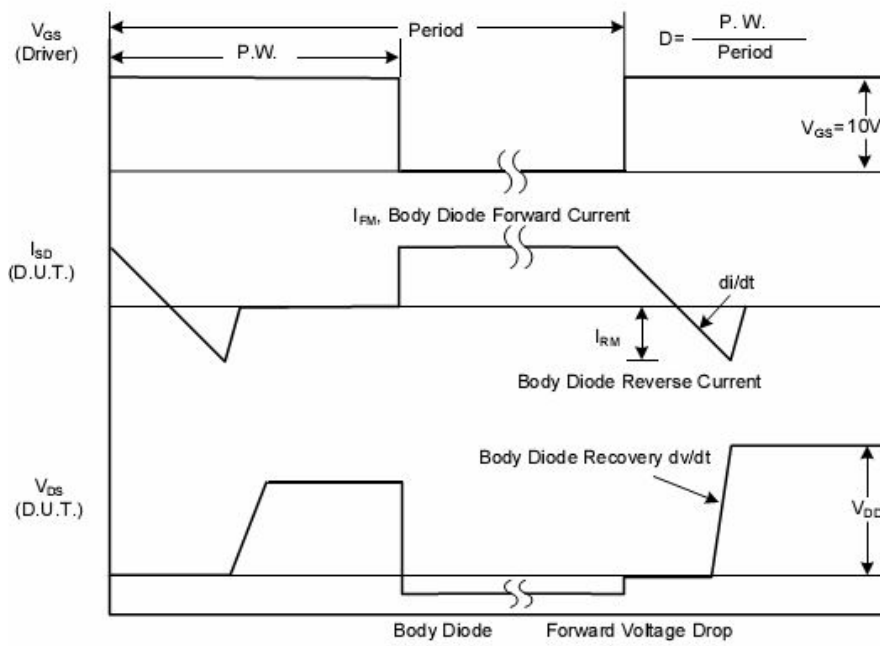

Fig. 1B Peak Diode Recovery dv/dt Waveforms

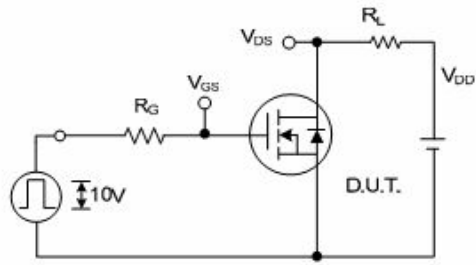

Fig. 2A Switching Test Circuit

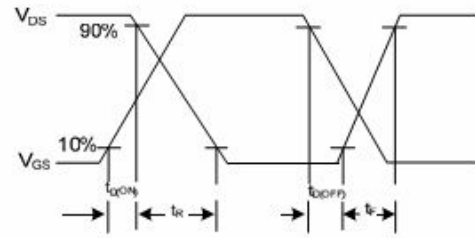

Fig. 2B Switching Waveforms

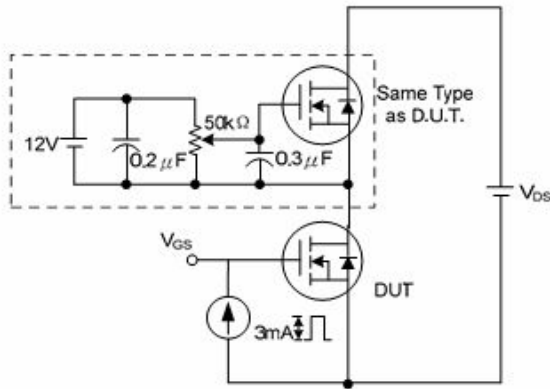

Fig. 3A Gate Charge Test Circuit

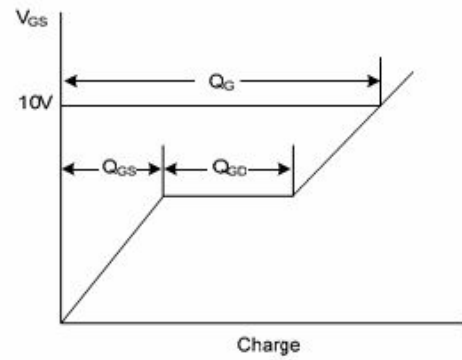

Fig. 3B Gate Charge Waveform

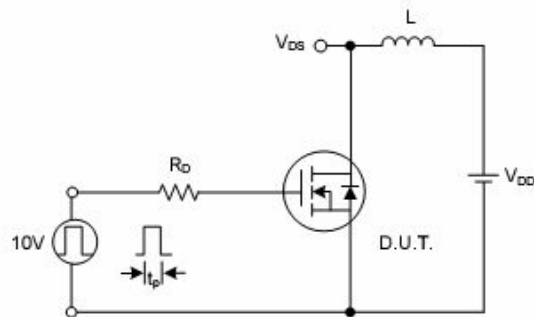

Fig. 4A Unclamped Inductive Switching Test Circuit

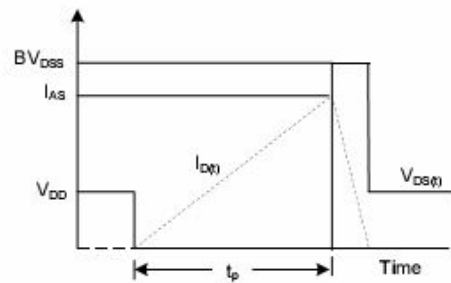

Fig. 4B Unclamped Inductive Switching Waveforms

Mechanical Dimensions

