

TS4N60

600V N-Channel Mosfet

DRAWING

features

- ◆ 4.0A,600V, $R_{DS(ON)}=2.5\Omega@V_{GS}=10V$
- ◆ Low gate charge(typical 22nc)
- ◆ Low Crss (typical 14pF)
- ◆ Fast switching
- ◆ 100%avalanche tested
- ◆ Improved dv/dt capability



G D S

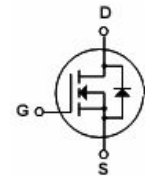

General Description

- ◆ Package:ITO-220AB
- ◆ This advanced technology has been especially tailored to Minimize on-state resistance, provide superior switching Performance, and withstand high energy pulse in the Avalanche and commutation mode. These devices are well Suited for high efficiency switch mode power supply.

Absolute Maximum Ratings

Symbol	Parameter	Spec	Units
V_{DSS}	Drain-Source Voltage	600	V
I_D	Drain Current -Continuous($T_c=25^\circ C$)	4	A
	-Continuous($T_c=100^\circ C$)	2.5	A
I_{DM}	Drain Current -Pulsed (Note 1)	16	A
V_{GSS}	Gate-Source Voltage	± 30	V
E_{AS}	Single Pulsed Avalanche Energy (Note 2)	240	mJ
I_{AR}	Avalanche Current (Note 1)	4	A
E_{AR}	Repetitive Avalanche Energy (Note 1)	10	mJ
dv/dt	Peak Diode Recovery dv/dt (Note 3)	5.5	V/ns
P_D	Power Dissipation ($TC=25^\circ C$)	30	W
	-Derate above $25^\circ C$	0.26	W/ $^\circ C$
T_j, T_{STG}	Operating and Storage Temperature Range	-55 to +150	$^\circ C$
T_L	Maximum lead temperature for soldering purpose 1/8" from case for 5 seconds	300	$^\circ C$

Thermal Characteristics

Symbol	Parameter	Typ	Max	Units
$R_{\theta JC}$	Thermal Resistance, Junction-to-Case	-	3.68	$^\circ C/W$
$R_{\theta JA}$	Thermal Resistance, Junction-to-Ambient	-	0.5	$^\circ C/W$
$R_{\theta JA}$	Thermal Resistance, Junction-to-Ambient	-	62.5	$^\circ C/W$

Electrical Characteristics(Tc=25°C unless otherwise noted)
Off Characteristics

Symbol	Parameter	Test Conditions	Min	Typ	Max	Units
BV _{DSS}	Drain-Source Breakdown Voltage	V _{GS} =0V, I _D =250uA	600	—	—	V
BV _{DSS/TJ}	Breakdown Voltage Temperature Coefficient	ID=250uA, Referenced to 25°C	—	0.65	—	V/°C
I _{DSS}	Zero Gate Voltage Drain Current	V _{DS} =600V, V _{GS} =0V	—	—	1	uA
		V _{DS} =480V, T _C =125°C	—	—	100	uA
I _{GSSF}	Gate-Body Leakage Current, Forward	V _{GS} =30V, V _{DS} =0V	—	—	100	nA
I _{GSSR}	Gate-Body Leakage Current, Reverse	V _{GS} =-30V, V _{DS} =0V	—	—	-100	nA

On Characteristics

Symbol	Parameter	Test Conditions	Min	Typ	Max	Units
V _{GSTH}	Gate Threshold Voltage	V _{DS} =V _{GS} , I _D =250uA	2	—	5	V
R _{DSON}	Static Drain-Source On-Resistance	V _{GS} =10V, I _D =2.2A	—	2.0	2.5	Ω
G _{fs}	Forward Transconductance	V _{DS} =40V, I _D =2.0A (Note 4)	—	4.7	—	S

Dynamic Characteristics

Symbol	Parameter	Test Conditions	Min	Typ	Max	Units
C _{JSS}	Input Capacitance	V _{DS} =25V, V _{GS} =0V, f=1.0MHz	—	710	920	pF
C _{OSS}	Output Capacitance		—	65	85	pF
C _{rss}	Reverse Transfer Capacitance		—	14	19	pF

Switching Characteristics

Symbol	Parameter	Test Conditions	Min	Typ	Max	Units
t _{don}	Turn-On Delay Time	V _{DD} =300V I _D =4.0A R _G =25Ω (Note 4 .5)	—	20	50	ns
t _r	Turn-On Rise Time		—	55	120	ns
t _{doff}	Turn-Off Delay Time		—	70	150	ns
t _f	Turn-Off Fall Time		—	55	120	ns
Q _g	Total Gate Charge	V _{DS} =480V	—	22	29	nc
Q _{gs}	Gate-Source Charge	I _D =4.0A	—	4.8	—	nc
Q _{gd}	Gate-Drain Charge	V _{GS} =10V (Note 4 .5)	—	8.5	—	nc

Drain-Source Diode Characteristics and Maximum Ratings

Symbol	Parameter	Test Conditions	Min	Typ	Max	Units
I _s	Maximum Continuous Drain-source diode forward current		—	—	4	A
I _{sm}	Maximum pulsed drain-source diode diode forward current		—	—	16	A
V _{sd}	Drain-source diode forward Voltage	V _{GS} =0V, I _S =5.0A	—	—	1.4	V
T _{rr}	Reverse Recovery Time	V _{GS} =0V, I _S =5.0A	—	330	—	ns
Q _{rr}	Reverse Recovery charge	dif/dt=100A/us (Note 4)	—	2.67	—	uc

Notes:

1. Repetitive Rating : Pulse width limited by maximum junction temperature
2. L = 27.5mH, I_{AS} = 4.0A, V_{DD} = 50V, R_G = 25 Ω, Starting T_J = 25°C
3. I_{SD} ≤ 4.0A, di/dt ≤ 300A/μs, V_{DD} ≤ BVDSS, Starting T_J = 25°C
4. Pulse Test : Pulse width ≤ 300μs, Duty cycle ≤ 2%
5. Essentially independent of operating temperature

Typical Characteristics

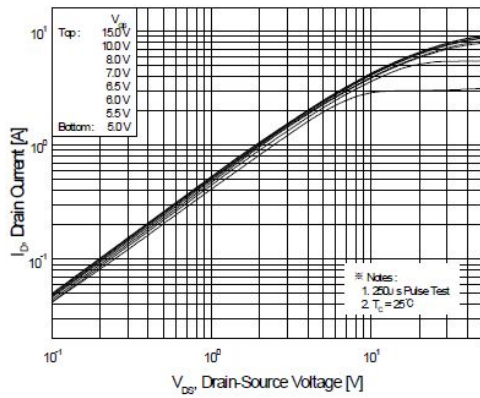

Figure1. On-Region Characteristics

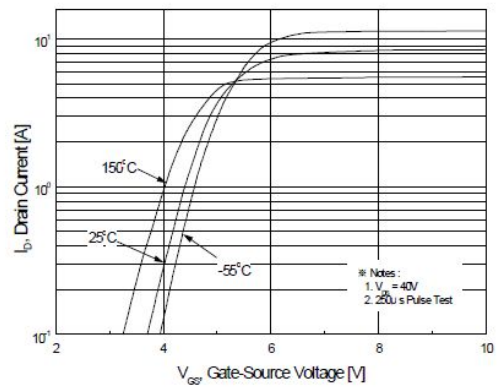

Figure2. Transfer Characteristics

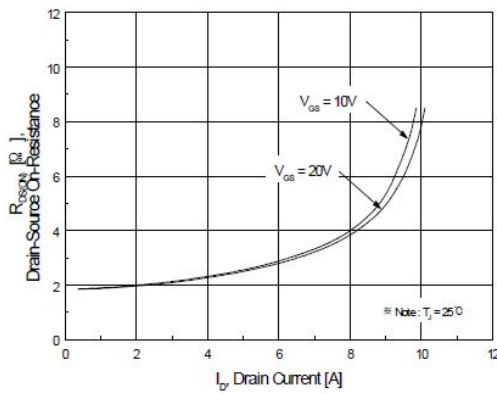

Figure3. On-Resistance Variation vs Drain Current and Gate Voltage

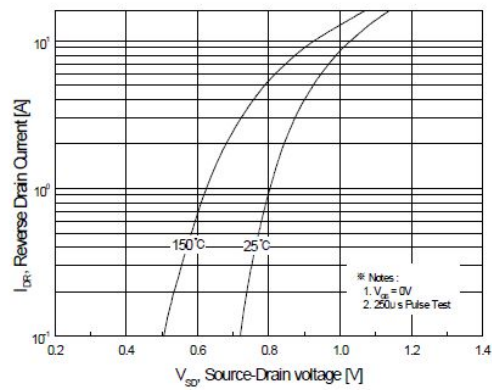

Figure4. Body Diode Forward Voltage Variation with Source Current and Temperature

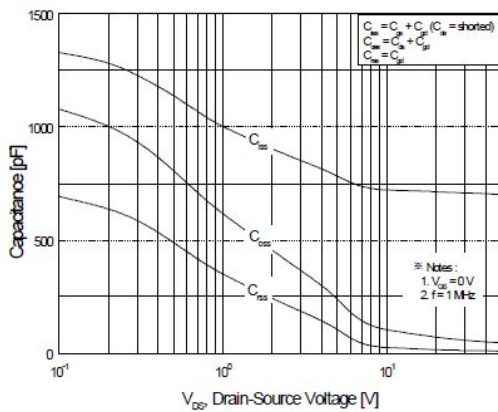

Figure5. Capacitance Characteristics

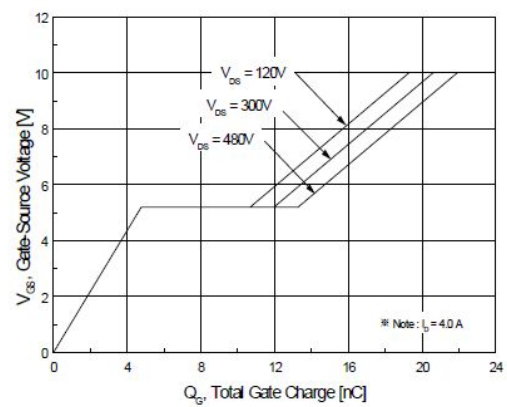

Figure6. Gate Charge Characteristics

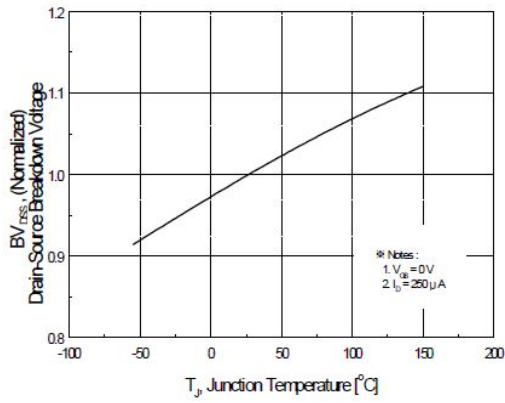

Figure7. Breakdown Voltage Variation vs Temperature

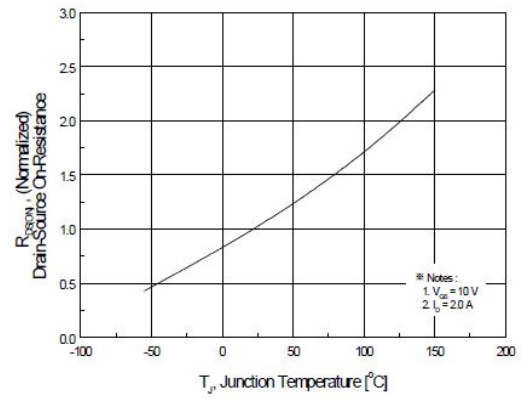

Figure8. On-Resistance Variation vs Temperature

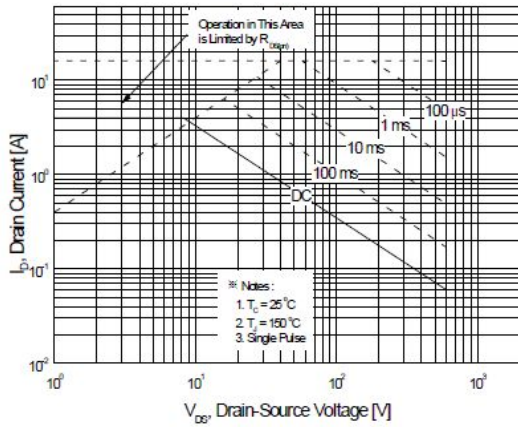

Figure9. Maximum Safe Operating Area

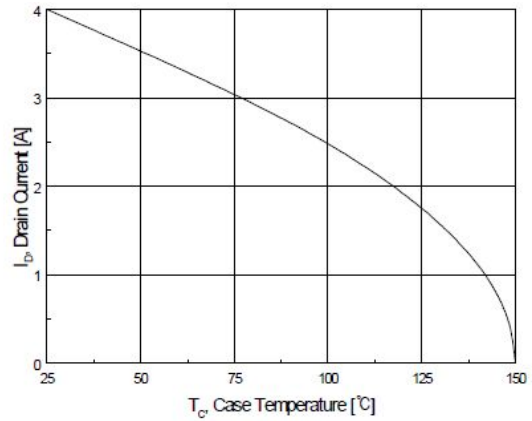

Figure10. Maximum Drain Current vs Case Temperature

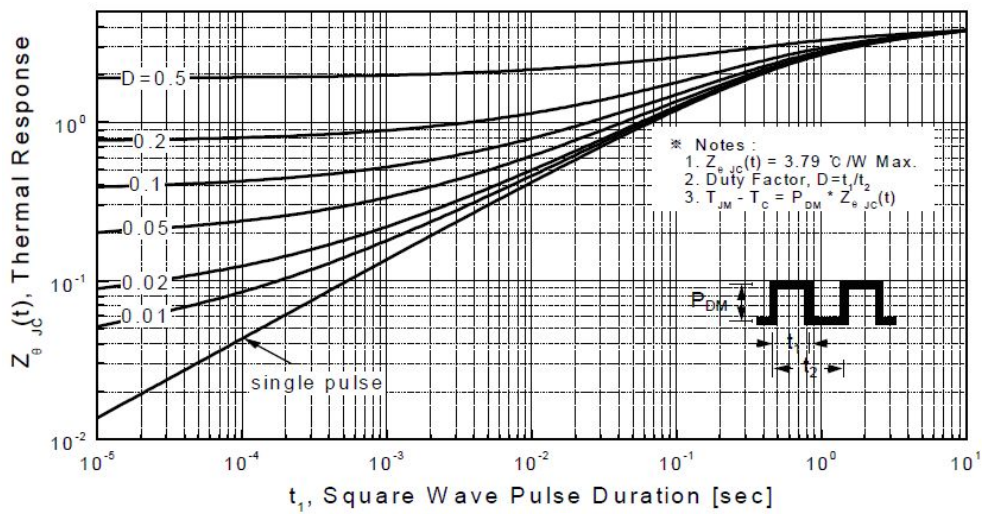
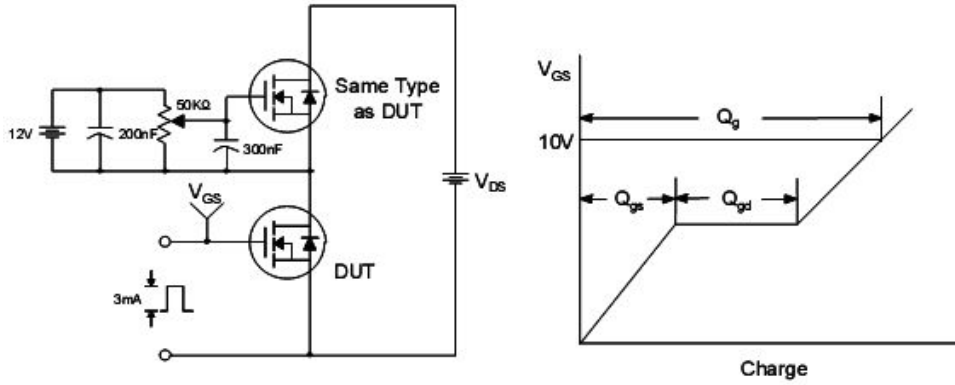

Figure11. Transient Thermal Response Curve

Test circuits and waveforms

Gate Charge Test Circuit & Waveform



Resistive Switching Test Circuit & Waveforms

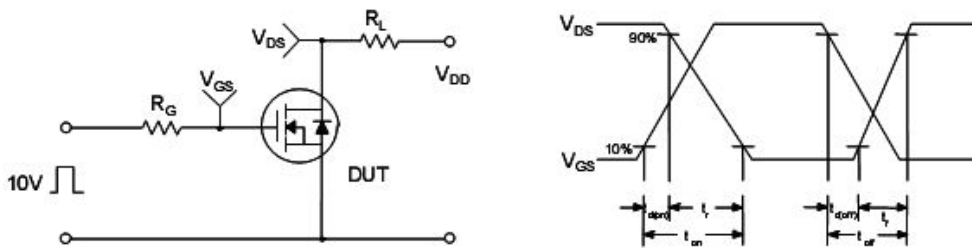

Unclamped Inductive Switching Test Circuit & Waveforms

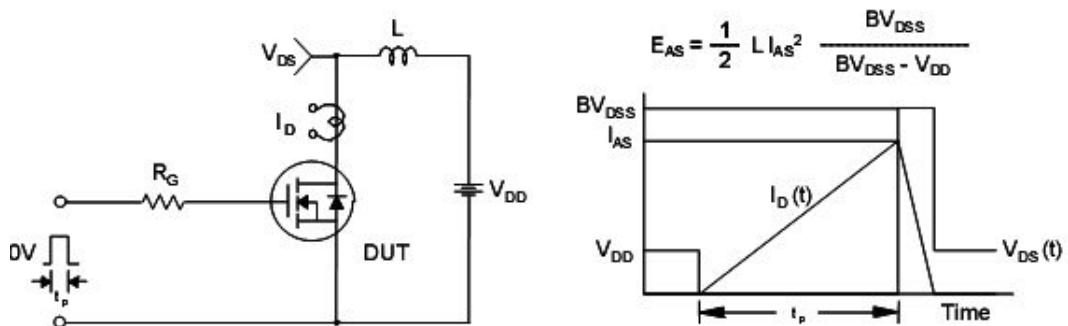

Peak Diode Recovery dv/dt Circuit & Waveforms

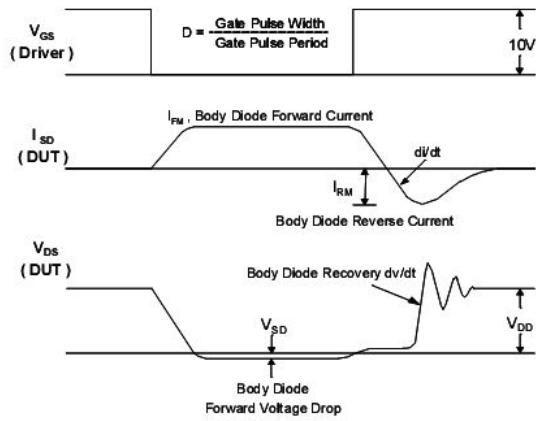
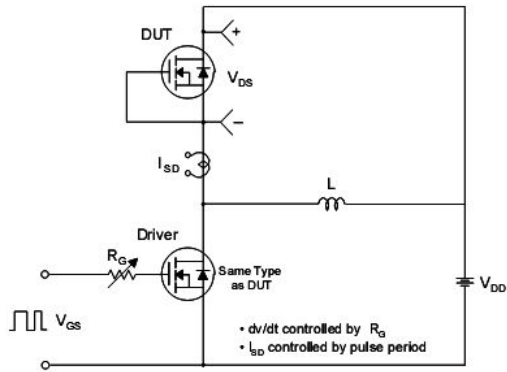

Mechanical Dimensions

